

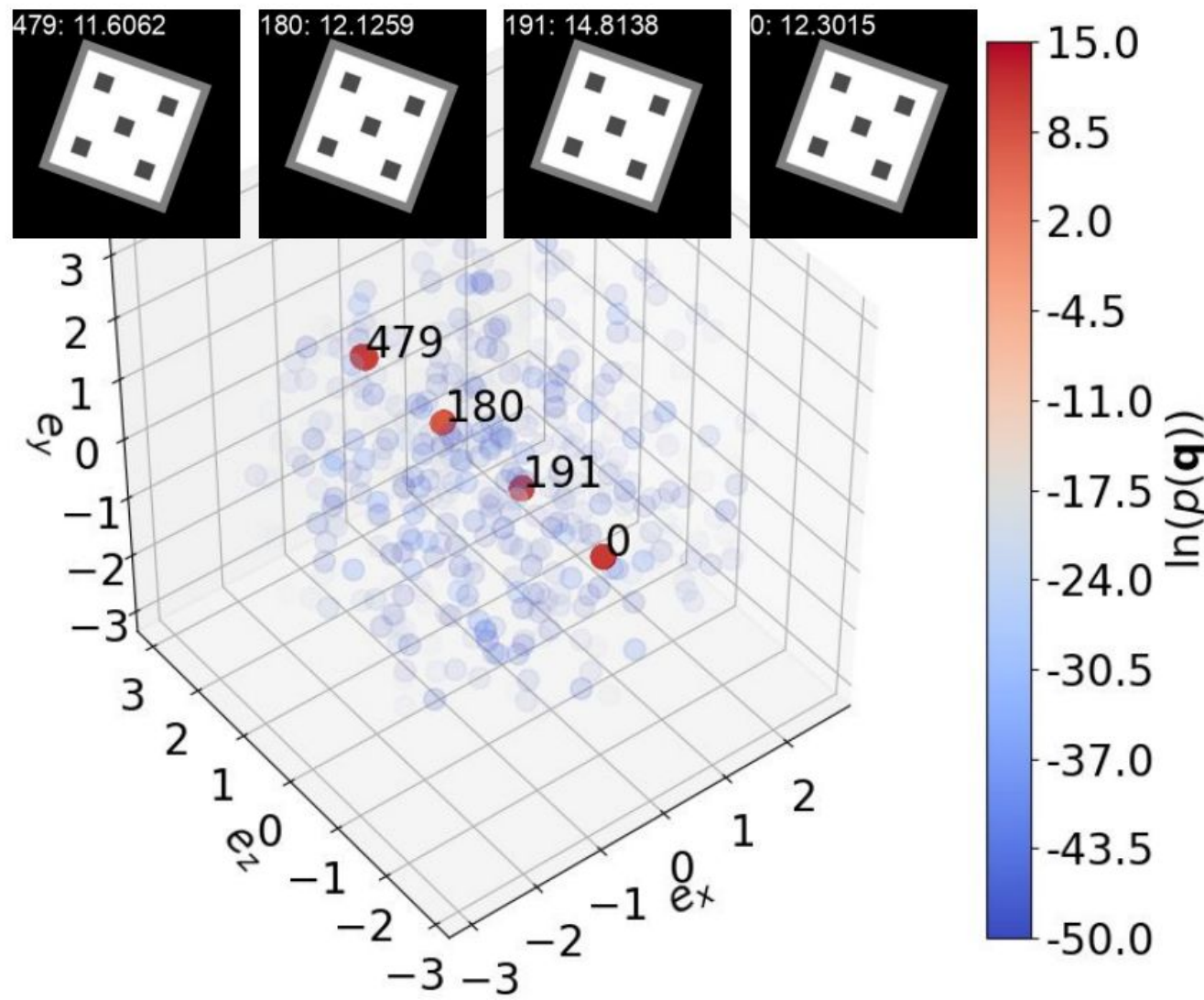

AQuaMaM: An Autoregressive, Quaternion Manifold Model for Rapidly Estimating Complex SO(3) Distributions

Michael A. Alcorn



Ambiguous/
Multimodal

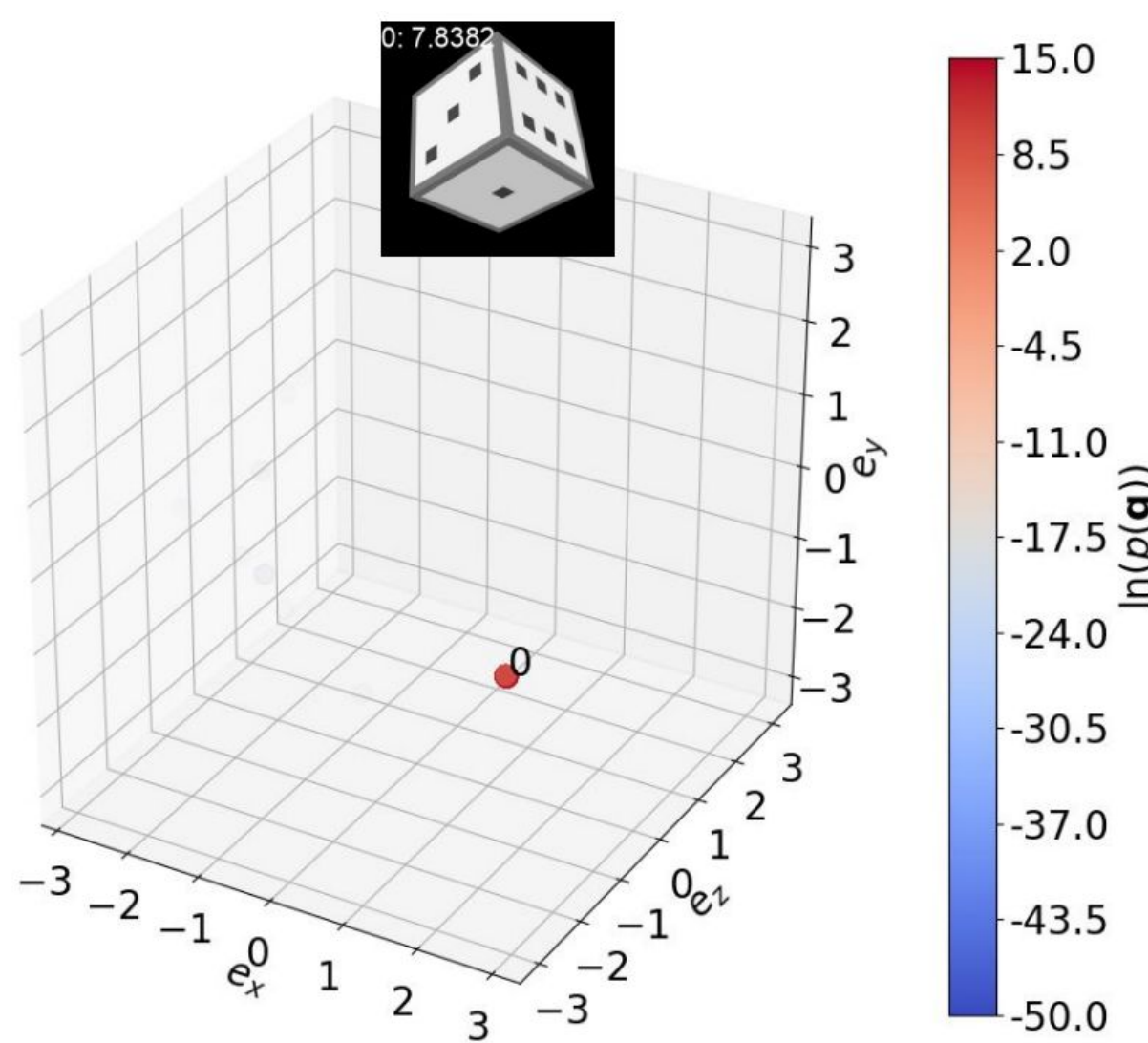

Unambiguous/
Peak

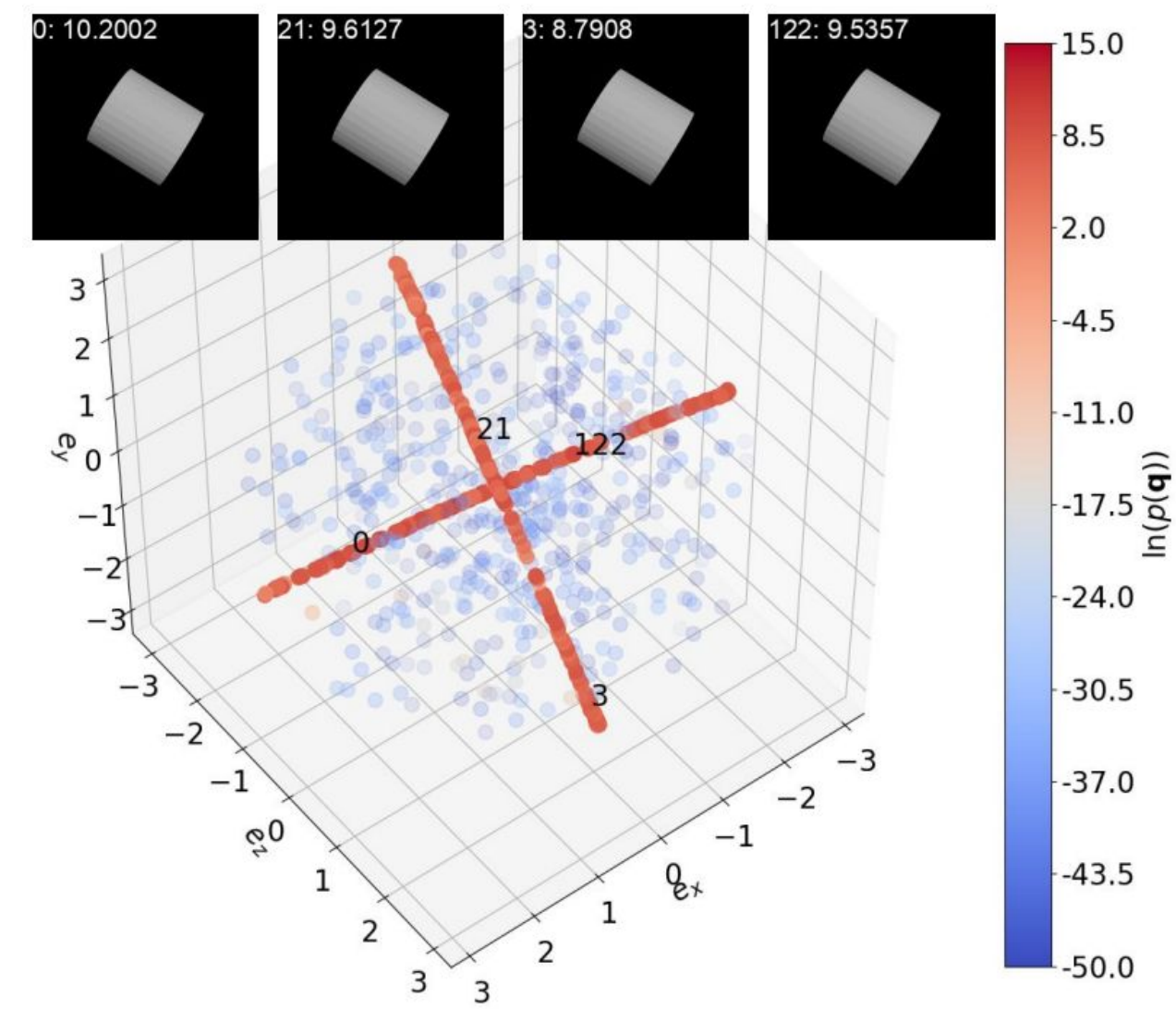

Continuous
Symmetry

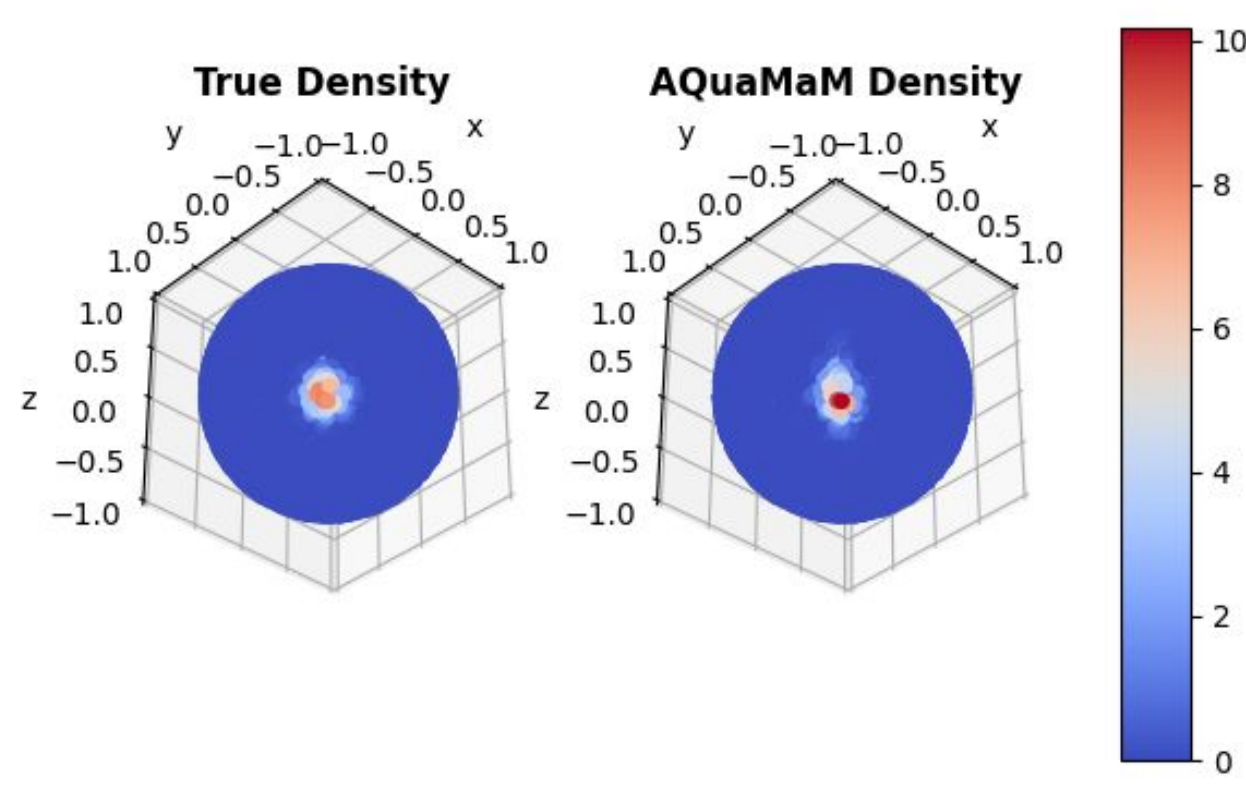
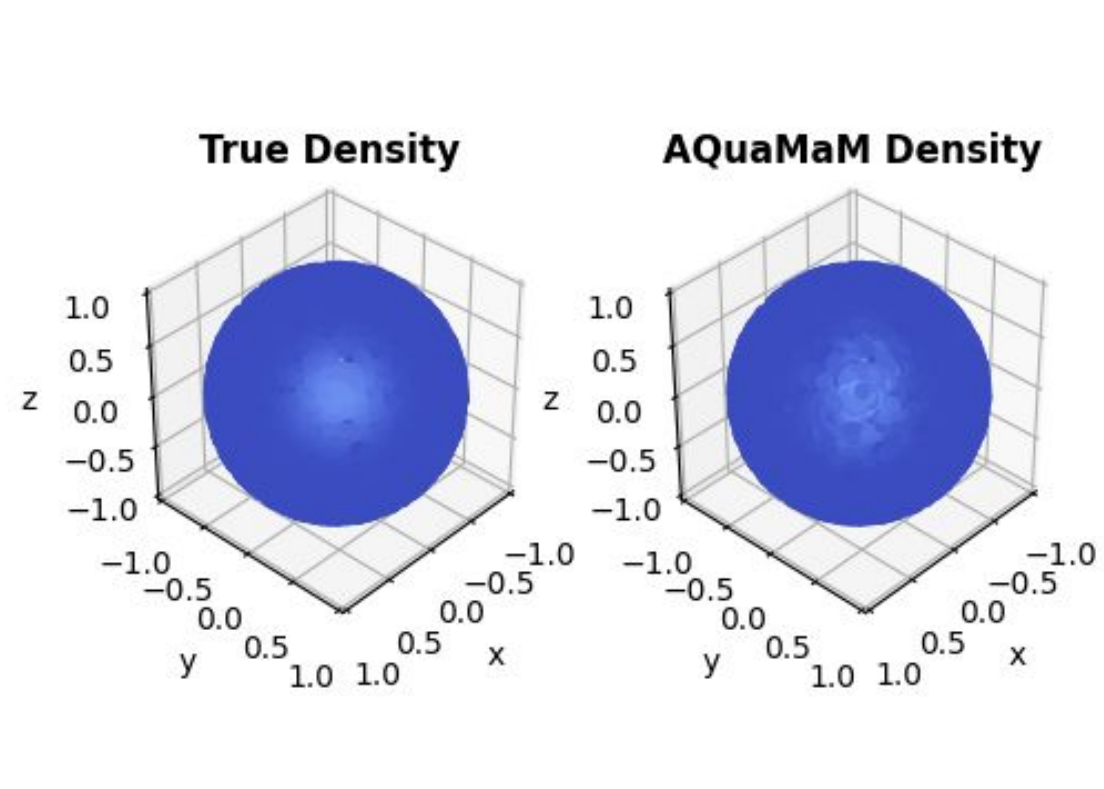

Mixture of two von
Mises-Fisher distributions
on a sphere

Architecture: ViT + "Quaternion Language Model"

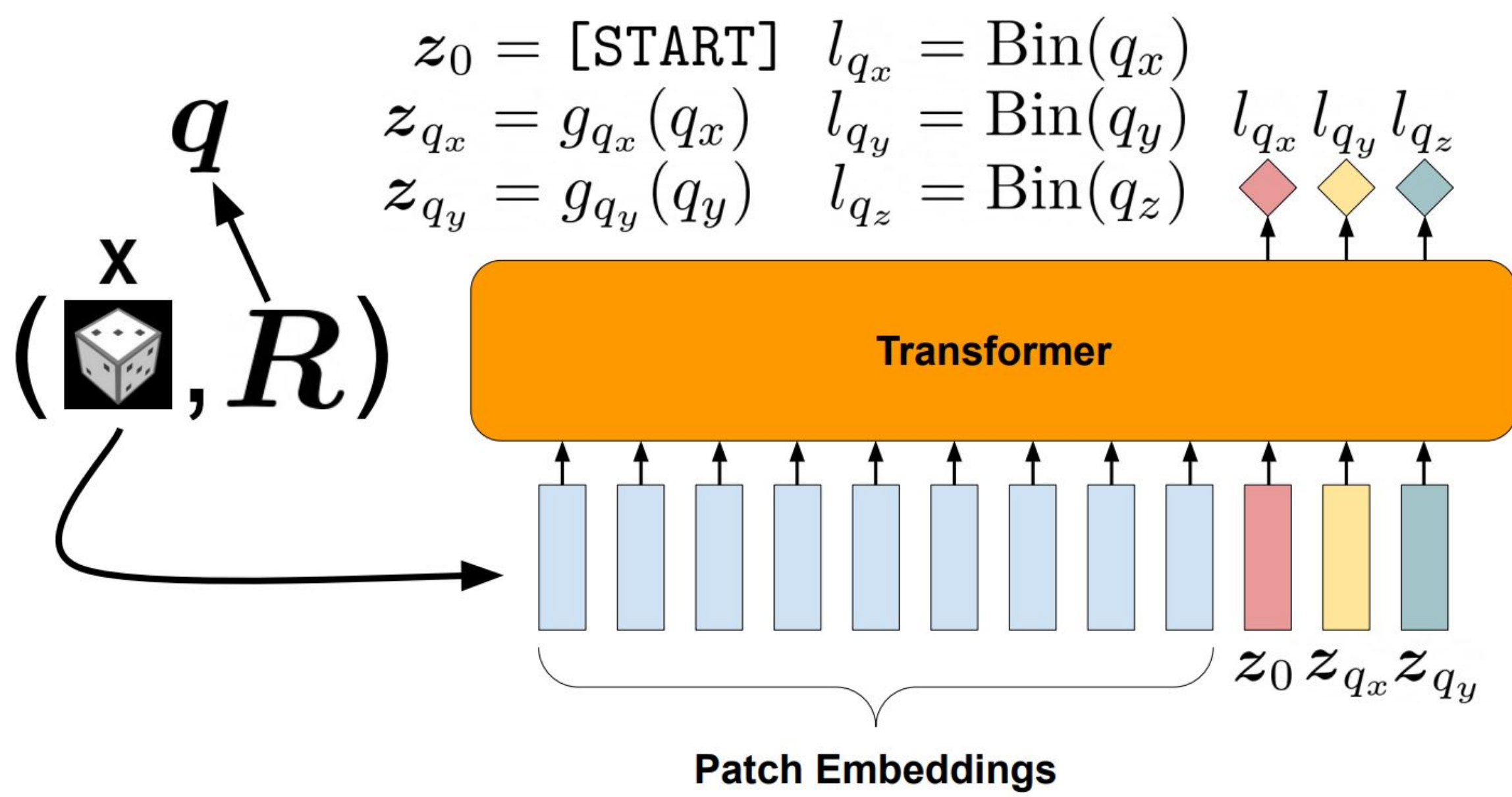

$$p(q_x, q_y, q_z) = \pi_{q_x} \frac{N}{2} \pi_{q_y} \frac{1}{\omega_{q_y}} \pi_{q_z} \frac{1}{\omega_{q_z}}$$

$$= \pi_{q_x} \pi_{q_y} \pi_{q_z} \frac{N}{2\omega_{q_y}\omega_{q_z}}$$

$$\mathcal{L} = - \sum_{d=1}^{|\mathcal{X}|} \ln \pi_{q_{d,x}} + \ln \pi_{q_{d,y}} + \ln \pi_{q_{d,z}} + \ln \frac{N q_{d,w}}{2\omega_{q_{d,y}}\omega_{q_{d,z}}}$$

Curved Hemisphere → Flat Ball (2D)

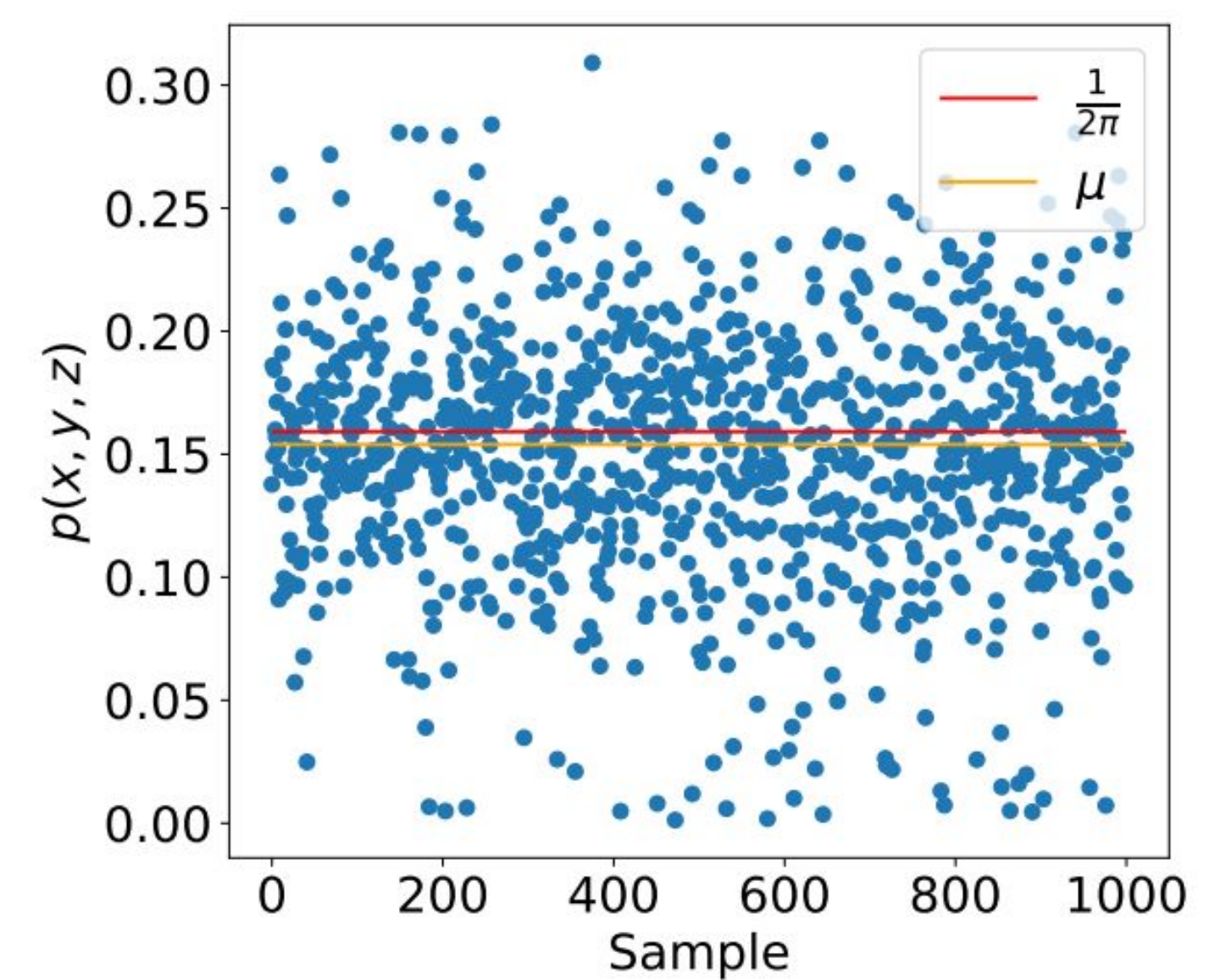
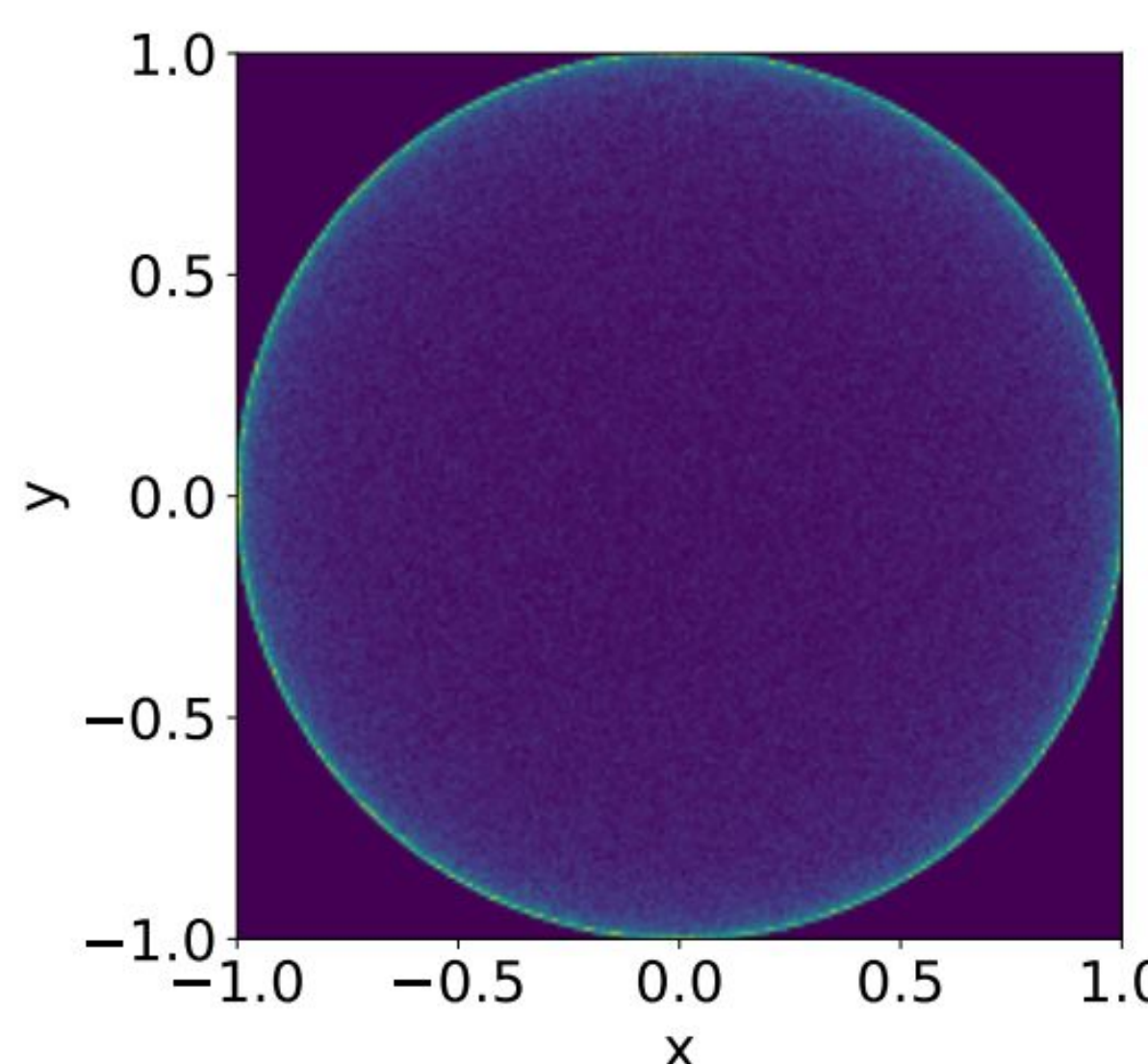
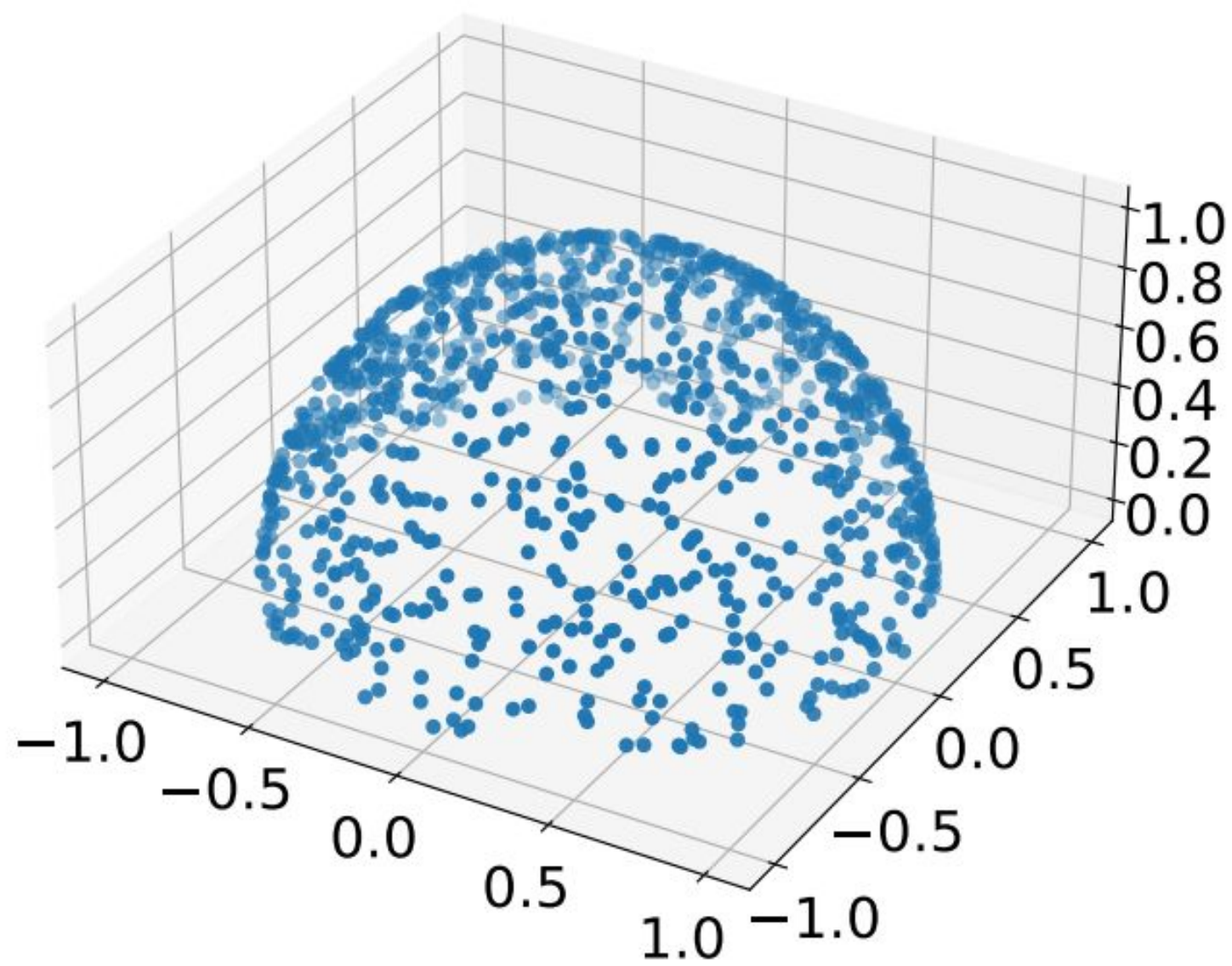

$$f(x, y) = [x, y, z]$$

$$z = \sqrt{1 - x^2 - y^2}$$

$$J = \begin{bmatrix} 1 & 0 \\ 0 & 1 \\ -x/z & -y/z \end{bmatrix}$$

$$a = \sqrt{\left| \begin{matrix} 0 & 1 \\ -x/z & -y/z \end{matrix} \right|^2 + \left| \begin{matrix} 1 & 0 \\ -x/z & -y/z \end{matrix} \right|^2 + \left| \begin{matrix} 1 & 0 \\ 0 & 1 \end{matrix} \right|^2}$$

$$= \sqrt{\frac{x^2}{z^2} + \frac{y^2}{z^2} + 1} = \sqrt{\frac{x^2 + y^2 + z^2}{z^2}} = \frac{1}{z}$$

$$p(x, y, z) = \frac{p(x, y)}{a}$$

$$= p(x, y)z$$

$$= p(x)p(y|x)z$$